

COMPRESSION FITTINGS - STANDARD SERIES

ACCESORIOS DE COMPRESIÓN - SERIE STANDARD

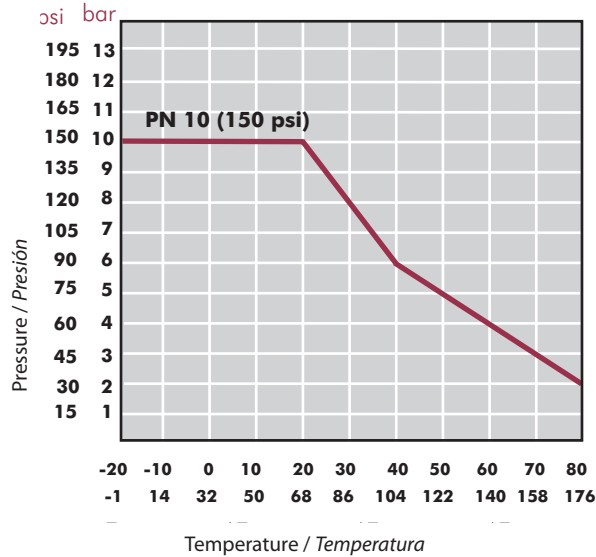

PRESSURE / TEMPERATURE GRAPH
DIAGRAMA PRESIÓN / TEMPERATURA



Life: 25 years
Hydrostatic maximum pressure a component may withstand in continuous service (without overpressure)

Vida útil: 25 años
Presión hidrostática máxima que un componente es capaz de soportar en servicio continuo (sin sobrepresión)

Performance of plastic materials in contact with non-dangerous fluids. The durability of those parts exposed to fluids will depend on the working conditions

Valores indicativos para materiales en contacto con fluidos no peligrosos. La vida en las partes expuestas a los fluidos dependerá de las condiciones de trabajo.

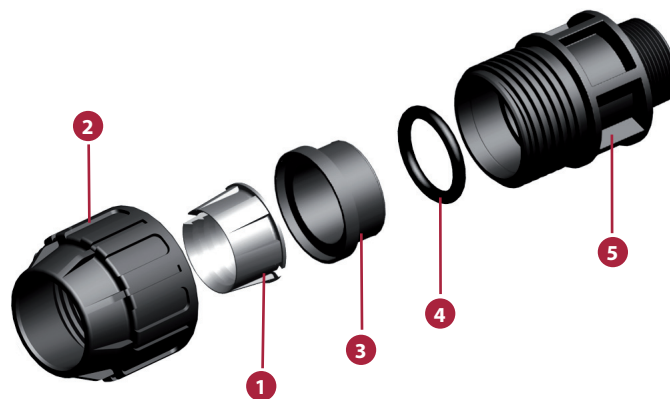

FIG.	Parts	Despiece	Material
1	Split ring	Cono de fijación	POM
2	Nut	Tuerca	PP
3	Insert	Casquillo prensa	PP
4	O-ring	Junta tórica	NBR 70
5	Body	Cuerpo	PP

ELBOWS
CODOS

PP-S. 01. CP - PP COMPRESSION ELBOW

90° elbow
• Comp x Comp

Codo 90°
• Comp x Comp

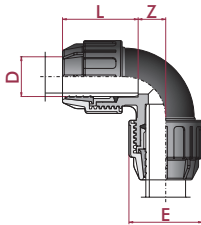

D	DN	PN	REF.	CODE
16 x 16	10	10	22 01 016	24671
20 x 20	15	10	22 01 020	24672
25 x 25	20	10	22 01 025	24673
32 x 32	25	10	22 01 032	24674
40 x 40	32	10	22 01 040	24675
50 x 50	40	10	22 01 050	24676
63 x 63	50	10	22 01 063	24677

L	Z	E
34	12	36
40	13	40
49	17	50
56	18	58
79	21	72
102	28	91
117	32	113

PP-S. 01. CPFT - PP COMPRESSION ELBOW

90° elbow
• Comp x BSP female thread

Codo 90°
• Comp x rosca hembra BSP

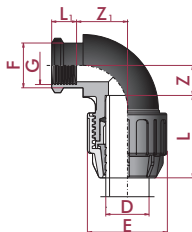

D x G	DN	PN	REF.	CODE
16 x 1/2"	10 x 15	10	22 01 417	24679
20 x 1/2"	15 x 15	10	22 01 420	24680
20 x 3/4"	15 x 20	10	22 01 421	24681
25 x 1/2"	20 x 15	10	22 01 424	24682
25 x 3/4"	20 x 20	10	22 01 425	24683
32 x 3/4"	25 x 20	10	22 01 431	24685
32 x 1"	25 x 25	10	22 01 432	24686
40 x 1 1/4"	32 x 32	10	22 01 440	24687
50 x 1 1/2"	40 x 40	10	22 01 450	24689
63 x 2"	50 x 50	10	22 01 463	24691

L	L ₁	Z	Z ₁	E	F
34	14	12	19	36	25
40	16	13	20	40	26
40	16	12	21	40	33
49	19	17	25	50	26
49	19	17	25	50	33
56	19	18	27	58	33
56	22	18	27	58	40
79	22	21	32	72	53
102	25	28	58	92	61
117	28	32	67	113	76

PP-S. 01. CPM T - PP COMPRESSION ELBOW

90° elbow
• Comp x BSP male thread

Codo 90°
• Comp x rosca macho BSP

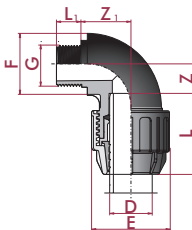

D x G	DN	PN	REF.	CODE
16 x 1/2"	10 x 15	10	22 01 617	24693
20 x 1/2"	15 x 15	10	22 01 620	24694
20 x 3/4"	15 x 20	10	22 01 621	24695
25 x 1/2"	20 x 15	10	22 01 624	24696
25 x 3/4"	20 x 20	10	22 01 625	24697
25 x 1"	20 x 25	10	22 01 626	25198
32 x 1"	25 x 25	10	22 01 632	24698
40 x 1 1/4"	32 x 32	10	22 01 640	24699
50 x 1 1/2"	40 x 40	10	22 01 650	24702
63 x 2"	50 x 50	10	22 01 663	24704

L	L ₁	Z	Z ₁	E	F
34	14	12	19	36	25
40	14	13	21	40	27
40	16	13	21	40	30
49	14	17	25	50	27
49	16	17	25	50	30
49	19	17	25	50	36
56	19	18	27	58	36
79	23	22	32	72	57
102	26	28	68	92	52
117	26	32	78	113	66

TEES
TÉS

PP-S. 03. CP - PP COMPRESSION TEE

90° Tee
• Comp x Comp x Comp

Té 90°
• Comp x Comp x Comp

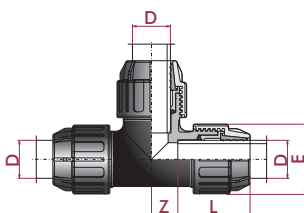

D	DN	PN	REF.	CODE
16 x 16 x 16	10	10	22 03 016	24707
20 x 20 x 20	15	10	22 03 020	24708
25 x 25 x 25	20	10	22 03 025	24709
32 x 32 x 32	25	10	22 03 032	24710
40 x 40 x 40	32	10	22 03 040	24711
50 x 50 x 50	40	10	22 03 050	24712
63 x 63 x 63	50	10	22 03 063	24713

L	Z	E
34	13	36
40	13	40
49	16	50
56	18	58
79	23	72
101	28	91
118	32	113

PP-S. 03. CPFT - PP COMPRESSION TEE
90° tee

• Comp x BSP female thread x Comp

Té 90°

• Comp x rosca hembra BSP x Comp

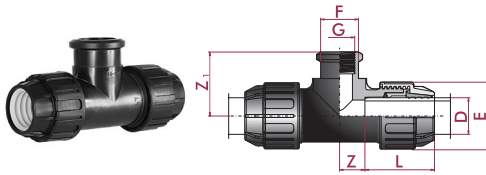

D x G x D	DN	PN	REF.	CODE
16 x 1/2" x 16	10 x 15	10	22 03 417	24633
20 x 1/2" x 20	15 x 15	10	22 03 420	24634
20 x 3/4" x 20	15 x 20	10	22 03 421	24635
25 x 1/2" x 25	20 x 15	10	22 03 424	24636
25 x 3/4" x 25	20 x 20	10	22 03 425	24637
32 x 1/2" x 32	25 x 15	10	22 03 430	24638
32 x 3/4" x 32	25 x 20	10	22 03 431	24639
32 x 1" x 32	25 x 25	10	22 03 432	24640
40 x 1 1/4" x 40	32 x 32	10	22 03 440	24641
50 x 1 1/2" x 50	40 x 50	10	22 03 450	24642
63 x 2" x 63	50 x 50	10	22 03 463	24644

L	Z	Z ₁	E	F
34	13	34	36	30
40	13	36	40	26
40	13	37	40	33
49	16	43	50	26
49	16	46	50	33
56	18	43	58	26
56	18	46	58	33
56	18	49	58	40
79	23	70	72	53
101	58	80	92	61
118	67	95	113	76

PP-S. 03. CPMT - PP COMPRESSION TEE
90° tee

• Comp x BSP male thread x Comp

Té 90°

• Comp x rosca macho BSP x Comp

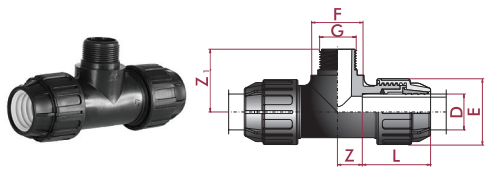

D x G x D	DN	PN	REF.	CODE
16 x 1/2" x 16	10 x 15	10	22 03 617	24646
20 x 1/2" x 20	15 x 15	10	22 03 620	24647
20 x 3/4" x 20	15 x 20	10	22 03 621	24648
25 x 1/2" x 25	20 x 15	10	22 03 624	24649
25 x 3/4" x 25	20 x 20	10	22 03 625	24650
32 x 1/2" x 32	25 x 15	10	22 03 630	24651
32 x 1" x 32	25 x 25	10	22 03 632	24652
40 x 1 1/4" x 40	32 x 32	10	22 03 640	24653
50 x 1 1/2" x 50	40 x 50	10	22 03 650	24655
63 x 2" x 63	50 x 50	10	22 03 663	24656

L	Z	Z ₁	E	F
34	13	34	36	24
40	13	35	40	27
40	12	37	40	30
49	16	41	50	27
49	16	43	50	30
56	18	41	58	27
56	18	46	58	36
79	28	70	72	44
101	58	89	91	52
118	67	104	113	66

**COUPLINGS
ENLACES**
PP-S. 05. CP - PP COMPRESSION COUPLING
Coupling

• Comp x Comp

Manguito

• Comp x Comp

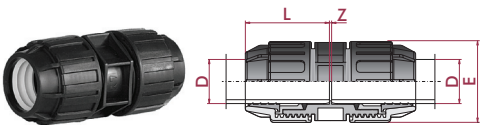

D	DN	PN	REF.	CODE
16 x 16	10	10	22 05 016	24657
20 x 20	15	10	22 05 020	24658
25 x 25	20	10	22 05 025	24659
32 x 32	25	10	22 05 032	24660
40 x 40	32	10	22 05 040	24661
50 x 50	40	10	22 05 050	24662
63 x 63	50	10	22 05 063	24663

L	Z	E
34	2	36
40	1	40
49	2	50
56	3	58
79	3	72
101	8	91
118	5	113

PP-S. 05. CPFT - PP COMPRESSION ADAPTOR
Adaptor

• Comp x BSP female thread

Enlace

• Comp x rosca hembra BSP

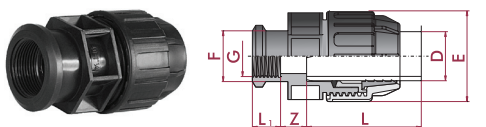

D x G	DN	PN	REF.	CODE
16 x 1/2"	10 x 15	10	22 05 417	24715
20 x 1/2"	15 x 15	10	22 05 420	24716
20 x 3/4"	15 x 20	10	22 05 421	24717
25 x 1/2"	20 x 15	10	22 05 424	24718
25 x 3/4"	20 x 20	10	22 05 425	24719
25 x 1"	20 x 25	10	22 05 426	24720
32 x 3/4"	25 x 20	10	22 05 431	24721
32 x 1"	25 x 25	10	22 05 432	24722
40 x 1"	32 x 25	10	22 05 439	24723
40 x 1 1/4"	32 x 32	10	22 05 440	24724
50 x 1 1/2"	40 x 50	10	22 05 450	24726
63 x 2"	50 x 50	10	22 05 463	24728

L	L ₁	Z	E	F
34	14	7	36	25
40	16	7	40	26
40	19	7	40	33
49	16	8	50	26
49	19	8	50	33
49	22	8	50	40
56	19	11	58	33
56	22	11	58	40
78	23	14	73	41
78	23	14	73	52
101	24	21	91	61
118	28	21	113	76

PP-S. 05. CPMT - PP COMPRESSION ADAPTOR

Adaptor

• Comp x BSP male thread

Enlace

• Comp x rosca macho BSP

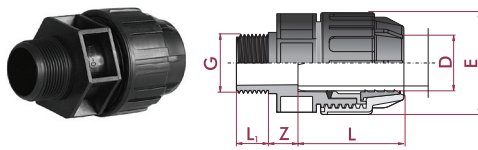

D x G	DN	PN	REF.	CODE
16 x 1/2"	10 x 15	10	22 05 617	24730
20 x 1/2"	15 x 15	10	22 05 620	24731
20 x 3/4"	15 x 20	10	22 05 621	24732
20 x 1"	15 x 25	10	22 05 622	24733
25 x 1/2"	20 x 15	10	22 05 624	24734
25 x 3/4"	20 x 20	10	22 05 625	24735
25 x 1"	20 x 25	10	22 05 626	24739
32 x 3/4"	25 x 20	10	22 05 631	24740
32 x 1"	25 x 25	10	22 05 632	24741
32 x 1 1/4"	25 x 32	10	22 05 633	24742
40 x 1 1/4"	32 x 32	10	22 05 640	24743
40 x 1 1/2"	32 x 40	10	22 05 641	24744
50 x 1 1/2"	40 x 40	10	22 05 650	24746
63 x 2"	50 x 50	10	22 05 663	24749

L	L ₁	Z	E
34	14	7	36
40	14	9	40
40	16	9	40
40	19	9	40
49	14	11	50
49	16	11	50
49	19	11	50
56	16	12	58
56	19	12	58
56	19	12	58
78	21	14	72
78	21	14	72
101	21	25	91
118	25	30	113

PP-S. 06. CPR - PP COMPRESSION REDUCER

Reducing coupling

• Comp x Comp

Manguito reducido

• Comp x Comp

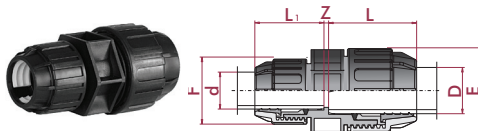

D x d	DN	PN	REF.	CODE
20 x 16	10	10	22 06 020	24664
25 x 20	15	10	22 06 025	24665
32 x 25	20	10	22 06 032	24666
40 x 32	25	10	22 06 040	24667
50 x 40	32	10	22 06 050	24668
63 x 50	40	10	22 06 063	24669

L	L ₁	Z	E	F
33	68	3	40	25
49	33	3	50	40
56	47	3	58	52
78	56	3	72	58
108	92	5	91	72
125	108	8	113	91

CAPS TAPONES

PP-S. 07. CP - PP COMPRESSION CAP

Cap

• Comp

Tapón

• Comp

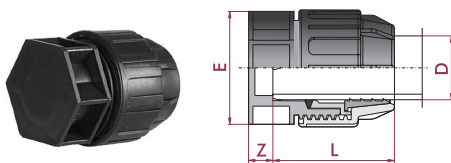

D	DN	PN	REF.	CODE
16	10	10	22 07 016	24750
20	15	10	22 07 020	24751
25	20	10	22 07 025	24752
32	25	10	22 07 032	24753
40	32	10	22 07 040	24754
50	40	10	22 07 050	24755
63	50	10	22 07 063	24756

L	Z	E
34	3	36
40	3	40
49	10	50
56	13	58
78	14	72
108	23	92
125	25	114